

AHM-PIPE

Submarine Cable Protection System

AHM-Pipe 250-750 Technical Specification

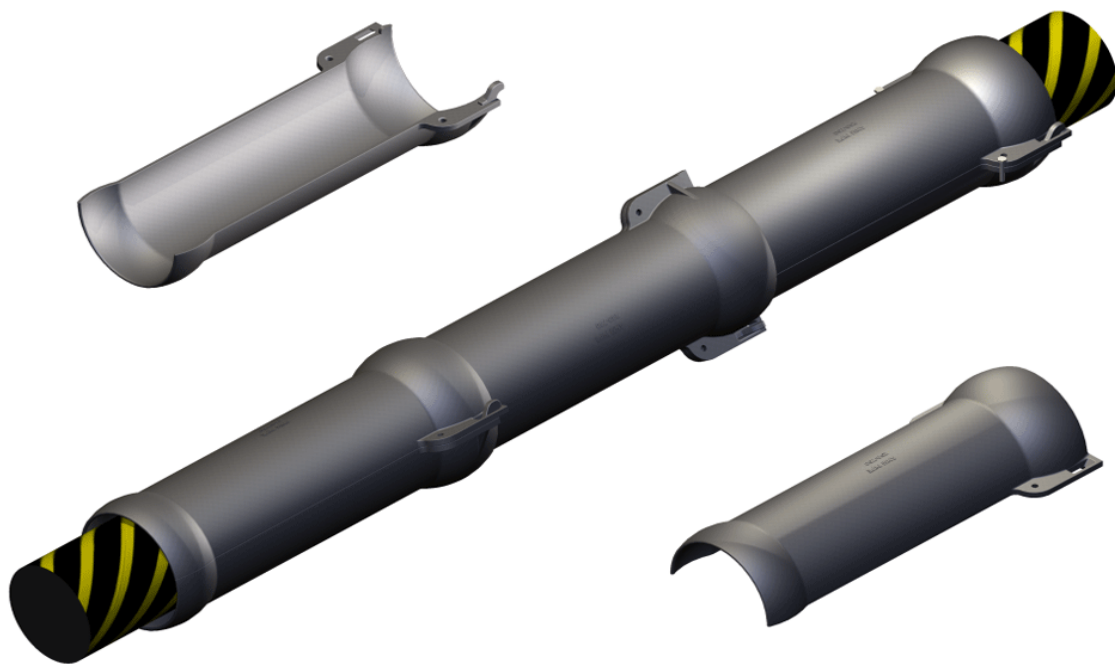

Overall segment length	: 862 mm
Effective segment length	: 750 mm
Inner diameter minimum	: 250 mm (suitable for cables up to 222 mm outer diameter)
Outer diameter maximum	: 368 mm
Minimum bending radius	: 4.30 m
Typical bending radius	: 4.73 m
Weight per segment	: 22.3 kg
Weight per section	: 44.6 kg
Weight per meter in air	: 59.5 kg
Weight per meter in seawater	: 51.1 kg
Material	: EN-GJS-400-15 (DIN EN 1563)
Pipe impact resistance	: > 5 kJ (ISO 13628-1 & Norsok U-001)
Pipe tensile strength	: > 405 kN
Abrasions resistance	: Good
Corrosion resistance	: Very Good
Average material loss	: 0.10 mm/year (ISO 11306 & DIN 81249-2)
Recommended bolt type	: M10 x 50 - 8.8 (ISO 4014 or ISO 4017)
Recommended nut type	: M10 - 8 (ISO 4032)

The AHM-Pipe submarine cable protectors are formed out of two identical half-shells which form a self-locking articulated pipe. Due to its design the AHM-Pipe can be installed in various manners to obtain the protection that submarine cables require. During installation AHM-Pipe can either be fitted directly to the submarine cable and could be floated-out during e.g. shore end installation or can alternatively be installed by divers once the submarine cable has already been laid. Typical installation locations include but are not limited to shore end, subsea crossings and areas with extreme environmental conditions.

Siem Offshore Contractors GmbH
Bavinkstrasse 23 - Block E
D-26789 Leer / Germany
Tel.: +49 (0)491 20980 500
Fax: +49 (0)491 20980 509
Email: info@ahmtec.de
Web: www.ahmtec.de

AHMTEC
cable protection systems