

# AHM-PIPE

## Submarine Cable Protection System

### AHM-Pipe 325-500 Technical Specification

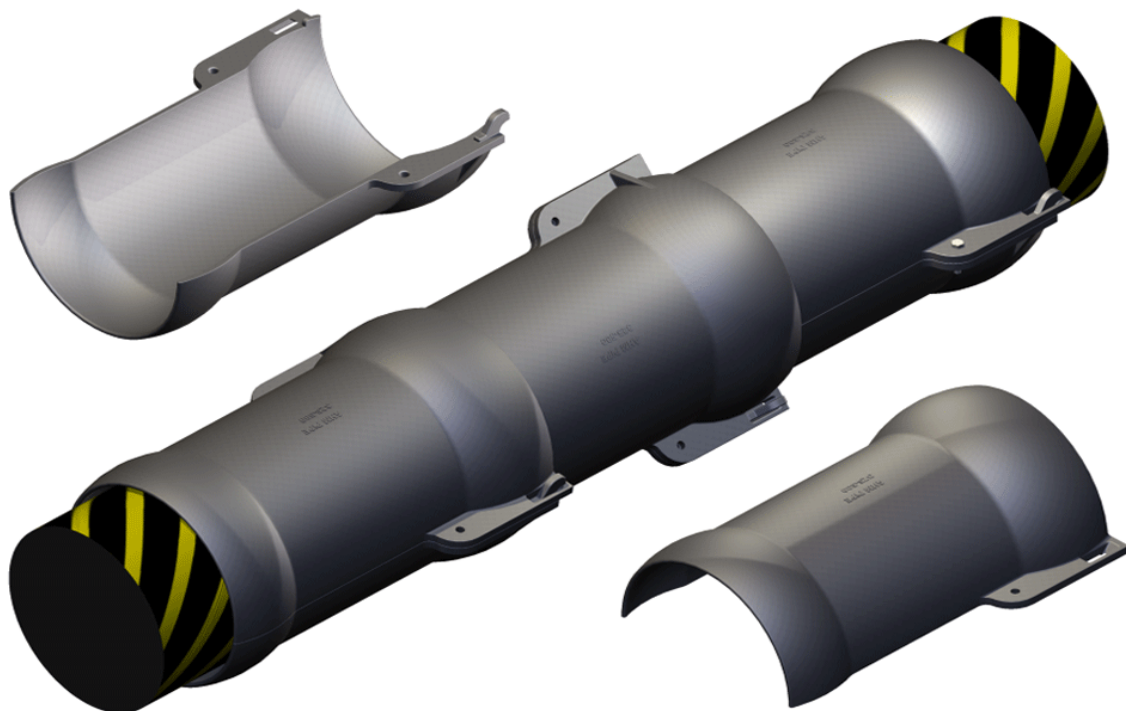

<b>Overall segment length</b>	: 630 mm
<b>Effective segment length</b>	: 500 mm
<b>Inner diameter minimum</b>	: 325 mm (suitable for cables up to 290 mm outer diameter)
<b>Outer diameter maximum</b>	: 443 mm
<b>Minimum bending radius</b>	: 2.86 m
<b>Typical bending radius</b>	: 3.15 m
<b>Weight per segment</b>	: 21.7 kg
<b>Weight per section</b>	: 43.4 kg
<b>Weight per meter in air</b>	: 86.8 kg
<b>Weight per meter in seawater</b>	: 74.6 kg
<b>Material</b>	: EN-GJS-400-15 (DIN EN 1563)
<b>Pipe impact resistance</b>	: > 5 kJ (ISO 13628-1 & Norsok U-001)
<b>Pipe tensile strength</b>	: > 523 kN
<b>Abrasions resistance</b>	: Good
<b>Corrosion resistance</b>	: Very Good
<b>Average material loss</b>	: 0.10 mm/year (ISO 11306 & DIN 81249-2)
<b>Recommended bolt type</b>	: M10 x 50 - 8.8 (ISO 4014 or ISO 4017)
<b>Recommended nut type</b>	: M10 - 8 (ISO 4032)

The AHM-Pipe submarine cable protectors are formed out of two identical half-shells which form a self-locking articulated pipe. Due to its design the AHM-Pipe can be installed in various manners to obtain the protection that submarine cables require. During installation AHM-Pipe can either be fitted directly to the submarine cable and could be floated-out during e.g. shore end installation or can alternatively be installed by divers once the submarine cable has already been laid. Typical installation locations include but are not limited to shore end, subsea crossings and areas with extreme environmental conditions.

Siem Offshore Contractors GmbH  
Bavinkstrasse 23 - Block E  
D-26789 Leer / Germany  
Tel.: +49 (0)491 20980 500  
Fax: +49 (0)491 20980 509  
Email: info@ahmtec.de  
Web: www.ahmtec.de

**AHMTEC**  
cable protection systems